

InCos-A transducer for passive sensors

InCos - A
InCos - A - A
InCos - A.. - CT

Subject to change!

Electrical, digital transducer only connectable for passive sensors
Pt 100, Pt 500, Pt 1000, Kd 250, Ni 100, Ni 200, Ni 500, Ni 1000,
Ni 1000 Siemens, Potentiometer
24 VAC/DC supply, 0...10 V / (0) 4...20 mA output

Transducer

Type	supply	installation area	connectable sensors	function of sensors	sensor connection	wiring
InCos - A	24 VAC/DC	safe area	PT100, PT1000, Ni100, ...	°C, %rH	via plug - and - socket connection	SB 1.0
InCos - A - A	as above, but with additional analogue output to connect an external digital indicator (0) 4...20 mA					SB 3.0
InCos - A.. - CT	Type as above but with Al housing and amercoat painting (sensor connection cable glands nickel-plated, screws in stainless steel)					

Applicaton

InCos-A... transducer



InCos-A..-CT Amercoat version

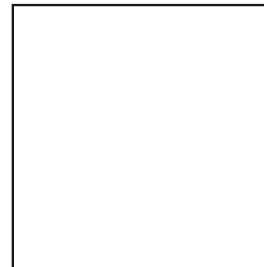
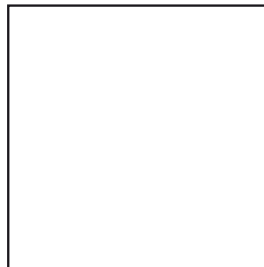

Description

The new InCos-A... transducer generation with direct connectable passive sensors are a revolution for measuring temperature or humidity in HVAC systems, in chemical, pharmaceutical, industrial and Offshore-/Onshore plants, for use in non hazardous areas zone.
IP 66 protection, small dimension, universal functions and technical data guarantee safe operation even under difficult environmental conditions. The measuring ranges are scalable within the maxium ranges. The analogue output signal is either 0...10 VDC or 4...20 mA and can be selected on site. The integrated display is for actual value indication which can be switched off.
All sensors are programmable on site without any additional tools.
InCos-A-A transducer are additionally equipped with a 4...20 mA output, e.g. for an external indicator.

Highlights transducer

- ▶ Industrial sensor
- ▶ Integrated junction box
- ▶ Power supply 24 VAC/DC
- ▶ Display with backlight, can be switched off
- ▶ Scalable analogue output, selectable 0...10 V / (0) 4...20 mA
- ▶ Compact design and small dimension (L x W x H = 180 x 107 x 66 mm)
- ▶ Robust aluminium housing in protection class IP66
- ▶ Down to -20°C ambient temperature applicable
- ▶ Password locking
- ▶ Optional output (4...20 mA) for external indicator
- ▶ CT versions have an excellent resistance to chemicals and sea water

Technical data	InCos-A...
Power supply	24 VAC/DC \pm 20% (19,2...28,8 VAC/DC) 50...60 Hz
Current, power consumption	150 mA, ~ 4 W, internal fuse 500 mA, without bracket, not removable
Galvanic isolation	supply – analogue output 1,5 kV
Electrical connection	terminals 0,14...2,5 mm ² at integrated junction box
Cable entry	2 \times M16 \times 1,5 mm cable diameter \sim \varnothing 5...10 mm (...CT in nickel-plated)
Protection class	Class I (grounded)
Display	2 \times 16 digits, dot-matrix with backlight, display for configuration, user guidance, parameter and actual value indication
Control elements	3 buttons for configuration
Housing protection	IP66 in acc. to IEC 60529
Housing material	aluminium casting, coated (...CT = version in marine painting, seawater-resistant)
Dimensions/weight	L \times W \times H = 180 \times 107 \times 66 mm/ca. 950 g
Ambient temperature/-humidity	-20...+50 °C / 0...95 %rH, non condensed
Storage temperature	-40...+70 °C
Sensor connection	only for passive sensors via plug-and-socket connection at front side of the transducer.
Measuring range	measuring ranges are scalable within the maximum measuring range
Maintenance	maintenance free, nevertheless maintenance must be complied with regional standards, rules and regulations
Start delay	5 sec.
Accuracy	\pm 0,4 % of end value + probe accuracy
Non linearity and hysteresis	\pm 0,10 %
Stability	long term stability < 0,2 %/year, temperature influence < 0,02 %/K, supply voltage influence < 0,01 %
Output	voltage U(V) or current I(mA) selectable via menu on site
Output protection	against short circuit and external voltage up to 24 V, protected against polarity reversal
Voltage output U	from 0...10 VDC adjustable, invertible, burden > 1 k Ω , influence < 0,05% / 100 Ω
Current output I	from 0...20 mA adjustable, invertible, burden < 500 Ω , influence < 0,1% / 100 Ω , open circuit voltage < 24 V
Output at alarm mode	increasing or decreasing output signal, selectable on site, down to 0 VDC/0 mA or up to 10 VDC/20 mA
Wiring diagram (SB)	SB 1.0
Delivery (changeable on site)	output 4...20 mA, output with decreasing alarm situation to 0 V/0 mA
Included in delivery	InCos-A.. with 3 screws 4,2 \times 13 mm self-tapping
Installation area transducer	in safe area

Additional information for InCos-A-A:

Analogue output	(0) 4...20 mA
Burden	max. 400 Ω
Accuracy	\pm 0,5 %
Plug	cable diameter \varnothing 6...8 mm
Delivery version ...-A-A	incl. 1 \times plug
Measuring range adjustable	
Pt100/500/1000	-160 °C...+500 °C
Ni100/200/500/1000 (Siemens)	-60 °C...+260 °C
KP250	-60 °C...+160 °C
1 k Ω /10 k Ω m	0...1,25 k Ω m/12,5 k Ω m

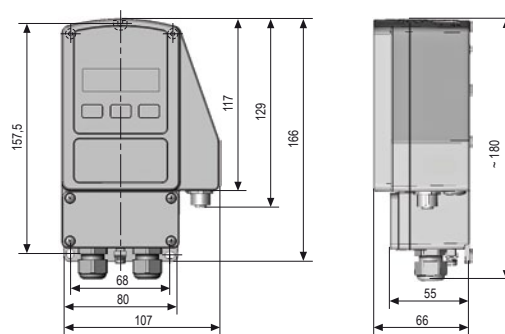
Dimensions / Drillings

Certification	InCos-D...
Identification	CE
EMC	89/336/EC EMC directive
Low voltage	73/23/EC low voltage directive
Protection type	IP66 in acc. to EN 60529
Potential compensation	external PA-terminal, 4 mm ²

Accessories	
NOC-RIA-261	LCD indicator, installation in safe area connectable direct to sensors with type InCos-A-A
MKR	Mounting bracket for round ducts up to \varnothing 600 mm

Electrical wiring

InCos-A... sensors required a 24 VAC/DC power supply. The supply has to be connected at terminal 1 (-/~) and 2 (+/~), the analogue output at terminal 3 (mA/V) and 4 (GND). The electrical wiring must be realized via integrated junction box.

Wiring diagram InCos-A... supply and analogue output

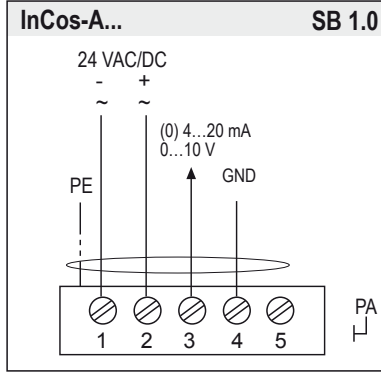

Wiring output (optional) at InCos-A-A transducer

Terminals SB 3.0

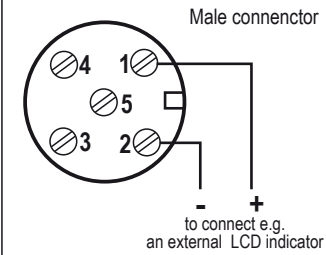

Open the plug, connect the wires. Use terminal acc. to diagram, close tighten. Unused connectors must be covered by a protective cap against mechanical damage and dirt

Head side of InCos-A-A sensor

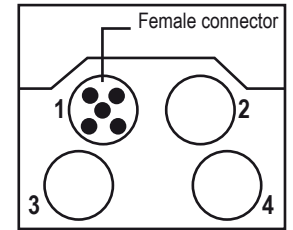

Connector 1 for output of sensor 1

Values

Umax = 16 V

Wiring passive sensors

Connect the wires max. 0,75 mm² are acc. to diagram. After than close threat tighten The cable diameter has to be between 6-8 mm.

Connectable sensors are:

Pt 100, Pt 500, Pt 1000, Kd 250

Ni 100, Ni 200, Ni 500, Ni 1000, Ni 1000 Siemens

resistor 0 - 1 kOhm, 0 - 10 kOhm

potentiometer 0 - 1 kOhm, 0 - 10 kOhm

Connection temperatur probe and resistor

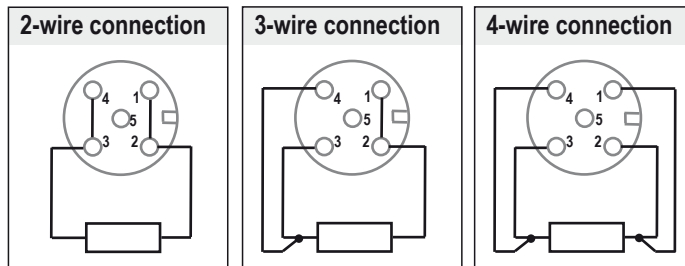

Connection potentiometer

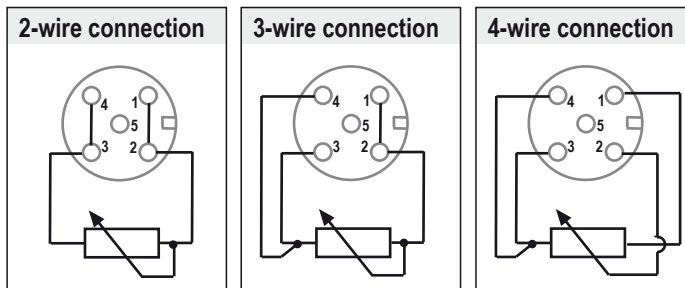

Values for passive sensors

Umax = 5,5 V

Parameter

Before starting parametrisation of InCos-A... transducer a passive sensor must be connected. In acc. with the sensor type you need to set parameter.

Display and Buttons

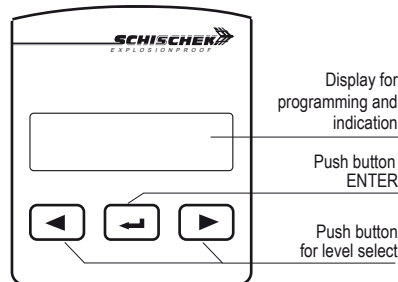

Indication of data logging

A blinking star in the display shows that datas received and the device is working.

Change operation-/parametrisation mode

To change from operation to parametrisation mode push "enter button"  for minimum 3 seconds.

Password input

The default/delivery setup is 0000. In this configuration the password input is not activated. To activate a password, go to menu point 20, change the 4 digits into your choosen numbers (e.g. 1234) and press Enter.

Please keep your password in mind for next parameter change!

Due to a new parameter setup the password is requested.

Important information for installation and operation

A. Installation, Commisioning, Maintenance

The cable has to be drawn through the cable gland. After electrical connection the cable gland must be fixed tighten. IP66 must be fulfilled.

In acc. with operation InCos sensors are maintenance free. Nevertheless maintenance must comply with regional standards, rules and regulations.

The sensors must not be opened by the customer. For outdoor installation a protective housing against rain, snow and sun should be applied. For electrical connection use the internal junction box.

B. Long cabling

For using long signal wires, shielded cables are recommended. The shield must be connected to the InCos-.. sensor inside the terminal box.

C. Separate ground wires

Use for supply and signal wires a separate ground.

Parametrisation and commissioning of InCos-A(-A) transducers after connection the passive sensor

Preparation of parametrisation/operation



Operation ↔ Parametrisation, push for 3 sec.

If password (PW) protection is active: put PW in, push

Change operation-/parametrisation mode

To change from operation to parametrisation mode push "enter button" for minimum 3 seconds. Back over the menu save and exit.

Example

Menu language english
Sensor PT100 / 3 wire
Range 0...+50°C,
Output 0...10 VDC
add. Output 4...20 mA

Menu	Function	Enter	Indication	Select	Enter	Next indication	Next selection	Enter	Next menu
Menu 1	DE, EN, FR select language: german, english, french		DE, EN, FR english						
Menu 2	type of sensor select sensor type		type of sensor PT100						
Menu 3	2-3-4 wire 2-3-4 wire connection		2-3-4 wire 3-wire						
Menu 4	Unit sensor select physical unit		unit sensor °C						
Menu 5	range adjust the measuring range		range 0..50 °C			range 0..50 °C			
			↑ adjust lower limit			↑ adjust higher limit			
Menu 6	display range * * only active at resistor and potentiometer		display range 0..50 °C			display range 0..50 °C			
			↑ adjust lower limit			↑ adjust higher limit			
Menu 7	output V, mA select output signal as VDC or mA		output V mA V						
			mA / V						
Menu 8	output range adjust the output range		output range 0..10V			output range 0..10V			
			↑ adjust lower limit			↑ adjust higher limit			
Menu 9	sensor error select signal at sensor error		sensor error 10V / 20 mA						
			10V / 20 mA or 0V / 0mA						
Menu 10	output select if signal output is increasing or decreasing		output increasing						
			increasing, decreasing						
Menu 11	no function - menu skip								
Menu 12	no function - menu skip								
Menu 13	no function - menu skip								
Menu 14	no function - menu skip								
Menu 15	no function - menu skip								
Menu 16	add. output (option, only at ..Cos-A-A) adjust 4...20 mA or 0...20 mA output signal		add. output 4..20 mA			add. output 4..20 mA			
			↑ adjust lower limit			↑ adjust higher limit			
Menu 17	no function - menu skip								
Menu 18	no function - menu skip								
Menu 19	display function select display on/off, illuminated or backlight off		display function on illuminated						
			on illuminated, on, off						
Menu 20	password select password protection		new password yes no			password 0000			
Menu 21	save and exit select save data / factory setting / discard or back to menu		save and exit save data						
Menu 22	Set offset Add / subtract from measures value		set offset 0.00°C						
Menu 23	no function - menu skip								